



M1000™

MOBILE HVLP SPRAY TAN SYSTEM
Instruction Manual and User Guide

NORVELL®

Norvell, A Division of Sunless Inc., the leader in designing, developing, and Manufacturing state of the art spray tanning systems for use within professional Salons, Spas, Health Clubs, Med Spas, and Tanning Salons is proud to introduce the Norvell M1000 spray tan system.

Our goal is to provide the highest quality tanning results along with unparalleled customer service, support and technology. As a customer having committed to such an investment you deserve nothing less.

Welcome to the Future of Sunless.



Read all safety information before operating the equipment.
Save these instructions.

Explanation of symbols used



This symbol indicates a potential danger to you or to the Spray Tan System. Under this symbol you can find important information on how to avoid injuries and damage to the Spray Tan System.



Indicates tips for use and other particularly useful information.

Field of application

The M1000 Spray Tan System has been specifically developed for the application of liquid spray tanning solution. Any application other than that described in this instruction manual is not permitted.

Important Safety Instructions



SAVE THESE INSTRUCTIONS. To reduce the risks of fire or explosion, electrical shock and the injury to persons, read and understand all instructions included in this manual. Be familiar with the controls and proper usage of the equipment.

- Risk of fire or explosion! Solvent and paint fumes can explode or ignite, causing severe injury and property damage.
- Paints and solvents containing HALOGENATED HYDROCARBONS can react explosively with aluminum. Always check the product's label before using these materials in the unit.
- Hazardous vapors: Paint, solvents, insecticides and other materials may be harmful if inhaled, causing severe nausea, fainting or poisoning.
- Make sure the room is well ventilated. Avoid all ignition sources, such as static electricity sparks, open flames, hot objects, sparks from connecting and disconnecting power cords, and working light switches.
- Follow the material and solvent manufacturers' safety precautions and warnings. Do not use liquids with flash points less than 100 degrees Fahrenheit (38 degrees Celsius).

- Static electricity can be produced by HVLP spraying. Make sure any electrically conductive object being sprayed is grounded to prevent static sparking. The sprayer is grounded to prevent static sparking. The M1000 is grounded through the electrical cord on the unit. If an extension cord is necessary, that extension cord must be a grounded three pronged cord. One that is made for the appropriate voltage used.
- Use a respirator or mask whenever there is a chance that vapors may be inhaled. Read all instructions with the mask to ensure that the mask will provide the necessary protection against the inhalation of harmful vapors.
- Do not carry the turbine while spraying.
- Keep the turbine at the maximum distance from the spraying area.

Grounding Instructions

This product must be properly grounded. In the event of an electrical short circuit, grounding reduces the risk of electrical shock by providing an alternate path for the electrical current.

This product is equipped with a cord that has a ground wire and an appropriate ground plug. Plug the unit into an outlet that is properly installed and grounded in accordance with local codes and ordinances.



Improper installation of the ground plug can result in the risk of electrical shock. If repair or replacement of the plug or cord is necessary, do not connect the ground wire to either flat blade terminal. The wire with green insulation (with or without a yellow stripe) is the grounding wire.

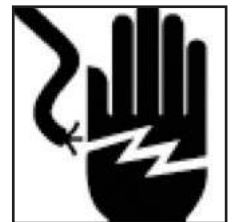

- For any question regarding proper installation of the ground plug, consult a qualified (licensed or certified) electrician.
- Do not modify the plug provided. If the plug does not fit the outlet, have the proper outlet installed by a qualified electrician.
- This product is for use on a nominal 120-volt circuit and has a grounding plug that looks like the plug in Figure 2. Make sure that the product is connected to an outlet having the same configuration as the plug. No adapters should be used with this product.
- If an extension cord is required, use only a three wire extension cord that has the same configuration as the unit cord, including the (round) ground terminal. Make sure that the extension cord is plugged into a properly grounded receptacle.
- When using an extension cord, be sure it is in good condition and heavy enough to meet the specifications in the chart below. If an extension cord is needed the following wire sizes must be used.
- (See Chart 1)

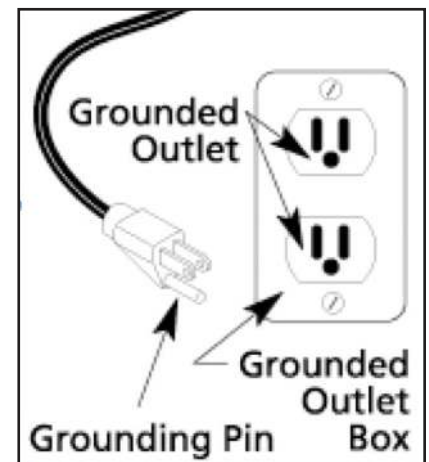

Fig. 2

25' cord10, 12, or 14 Gauge
50' cord10 or 12 Gauge
100' cord10 Gauge

Chart 1 Extension Cord Requirements

Set up and operate your Norvell M1000 Spray Tan System:

- Plug the Norvell M1000 HVLP spray tan system unit into a proper electrical outlet. Make sure that the electric current you are connecting is the same as your unit. (110v or 220v). DO NOT attempt to connect the unit to the wrong electric current as this will not only damage your unit but also void your warranty.
- Next, locate the male end of the air hose and connect it to the female quick connect on the M1000 spray tan system.
 - To insert the coupler pull back on the ring of the black coupler located on the M1000® system and connect it to the male connector on the hose. Figure 6.



Fig. 6

- Release the ring to allow the coupler to snap into place. The hose should now be connected to the unit. Figure 7.



Fig. 7

- To remove the air hose, pull back on the ring of the black coupler and remove.



If you have just finished spraying, the connector may be hot. Allow the M1000 HVLP unit to cool down for about 10 minutes before disconnecting the air hose from the HVLP unit. Use Caution!

M1000™

Prepare the M1000 Mobile Spray Gun

Parts List and Diagram

Norvell Customer Service
888-829-2831
norvelltanning.com

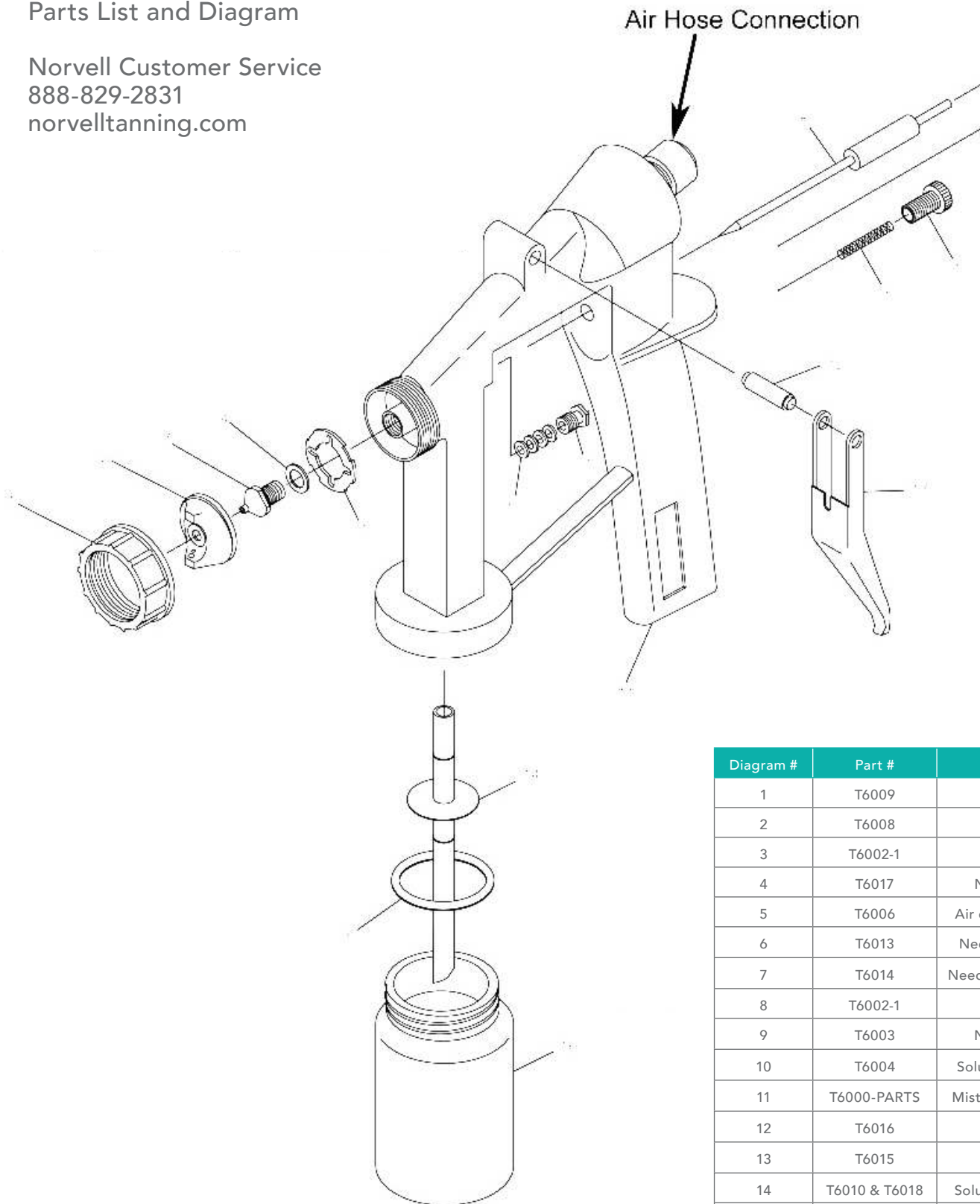

Diagram #	Part #	Description
1	T6009	Air cap ring
2	T6008	Air cap
3	T6002-1	Nozzle
4	T6017	Nozzle gasket
5	T6006	Air distributor plate
6	T6013	Needle packing (4)
7	T6014	Needle packing screw
8	T6002-1	Needle
9	T6003	Needle spring
10	T6004	Solution flow screw
11	T6000-PARTS	Mist applicator body
12	T6016	Trigger pin
13	T6015	Trigger
14	T6010 & T6018	Solution tube & disc
15	A5402	Cup gasket
16	A5401	Solution cup

Follow the diagram to prepare the Spray Gun

- Unscrew the plastic cup from the Spray Gun. Pour Norvell sunless tanning solution into the cup. Do not fill more than $\frac{3}{4}$ full.

▲ CAUTION

- Carefully screw the cup back onto the main body of the Spray Gun. Screw the cup on firmly but DO NOT over tighten. Over tightening will cause the cup to “pop” and damage the threads. Leakage will require replacement of the cup.
- Locate the air cap (#2) on the M1000 SPRAY GUN diagram. Slightly turn the air cap ring (#1) counter clockwise to loosen the air cap. Notice that you can now rotate the air cap freely.
- Look at Spray Gun Patterns diagram below. Note the position of the air cap and the direction of the spray pattern. Pattern 1 is for spraying side to side. Pattern 2 is for spraying up and down. Pattern 3 will produce a spot or circle. Patterns 1 and 2 are the most common positions for applying tanning solutions.
- Turn the air cap (#2) to the position you want. Turn the air cap ring (#1) clockwise to lock the air cap in place.



1. Spraying across from side to side
2. Spraying up and down
3. Spraying in a spot or circle

- Next, position the M1000 HVLP Unit as far away as practical and possible from the area where you will spray.
- Attach the remaining end of the hose to the M1000 HVLP Spray Gun as follows:
 - Locate the coupler at the rear top of the M1000 HVLP Spray Gun. See SPRAY GUN diagram.
 - Pull back on the collar of the black connector on the air hose.
 - Push the connector over the coupler and release. Figure 7.
 - Your Spray Gun should now be firmly attached to the air hose.



FIGURE 7

Adjusting the Spray Gun

- Locate the Solution Flow Screw (#10) on the M1000 SPRAY GUN diagram.
- Turning the Solution Flow Screw clockwise reduces and will eventually stop the flow of solution. DO NOT over-tighten the screw as this will cause damage to the end of the needle. Once the trigger cannot be pulled back there is no point in tightening the screw down more, this will only damage the end of the needle.
- Turning the Solution Flow Screw anti or counter clockwise will increase the flow of solution.
- In general, 1 ½–2 full turns from the fully closed position will provide a good solution flow. You may find that you want more or less solution. You can adjust the Solution Flow Screw to your desired setting. NOTE: Opening the Solution Flow Screw more than 3 turns will not increase the solution flow and will in fact decrease the efficiency of your Spray Gun
- In general, hold the M1000 Spray Gun 6" (10cm) from the person being sprayed. Moving the Spray Gun back will increase the size of the mist pattern. Moving the Spray Gun closer will decrease the size of the mist pattern. The further away you hold the Spray Gun, the more you will need to increase the solution flow thus causing abnormal amounts of airborne solution (overspray).
- Holding the Spray Gun closer to the person being sprayed along with a minimum flow of solution will provide the best results, no streaks or running solution and virtually no mist in the spray area.
- Be sure to move the Spray Gun at a slow, steady speed keeping the distance of the Spray Gun the same throughout the application. This will ensure perfect results. It is actually very easy. Practice a few times and you will be an expert.
- It is best to hold the Spray Gun in a vertical position when spraying. If you want to change the direction of the mist pattern, rotate the position of the air cap rather than turning the Spray Gun on its side.
- Always hold or store the Spray Gun in a vertical position. A slot in the M1000 HVLP Turbo Unit is provided to hold and store the Spray Gun. It is a good habit to use it when you are not spraying.

▲ CAUTION

- Do not over-tighten the solution flow screw (#10) as this will damage the end of the needle point. Tighten the screw until the needle cannot be pulled back. Once this point is reached there is no point in turning the solution slow screw anymore as this will only cause damage to the needle point.

Start Spraying:

- You are now ready to begin.
- The ON/OFF switch is located on the M1000 HVLP Spray Tan Unit as shown in image. Turn it on when ready.
- Open the Solution Flow Screw.
- Set the mist pattern you wish to use by adjusting the air cap to the desired position. Refer to Spray Gun Patterns.
- Direct the Spray Gun to the area of the body that you want to start spraying.
- Pull back on the trigger (#13) and move the Spray Gun as noted in the diagram below. Do not wave the Spray Gun back and forth in front of your client by bending your wrist. Rather, keep your wrist straight and move your entire arm. Movement should be steady, even and deliberate, keeping your distance the same at all times.

PROPER SPRAYING TECHNIQUE

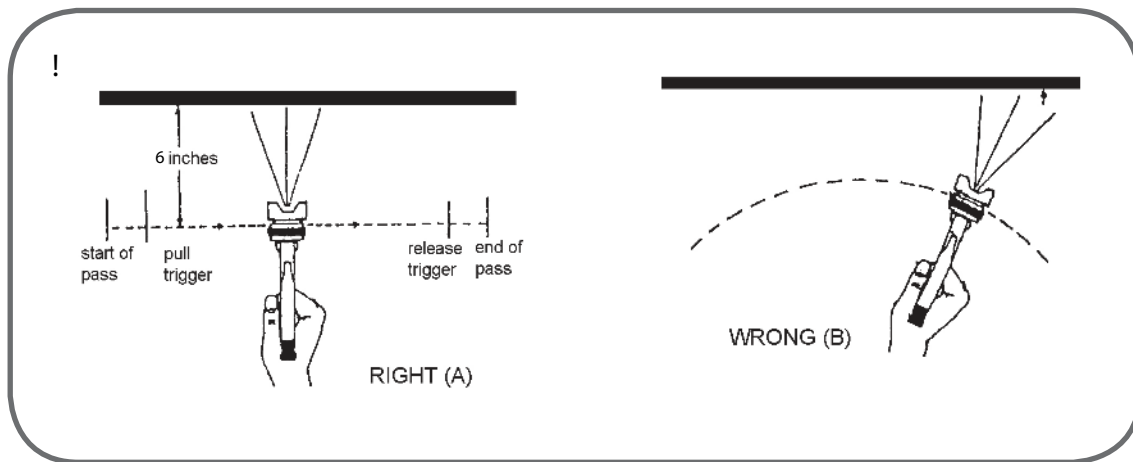

M1000 Spray Tan System

Norvell M1000 HVLP Spray Tan System

- The only maintenance necessary on the M1000 HVLP unit is cleaning and/or changing the filter element. The filter should be removed and rinsed out at least once daily or at least every 4 tanning sessions. The filter housing and filter are located on the under side of the M1000 HVLP Unit.
- To clean the filter, (See Figure 1)
- Place the M1000 HVLP Turbo unit on one side at a time. Using a small screwdriver insert the blade into the slot and push down and out at the same time. (See Figure 2-Do this on both sides)
- Using your thumb and index finger, pull the filter housing out. (See Figure 3)
- Pull the filter out of the filter housing to clean. (See Figure 4 & 5)

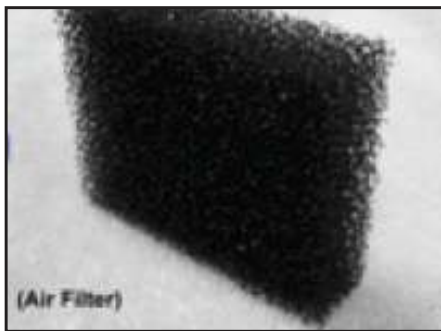

(Air Filter)

Air Filter

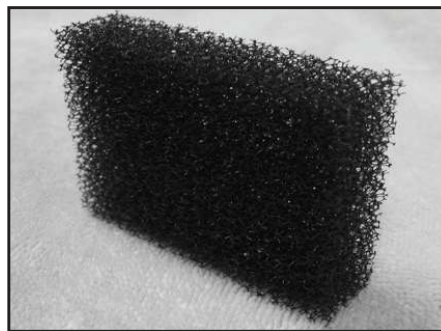

Air Filter



Air Filter



Air Filter

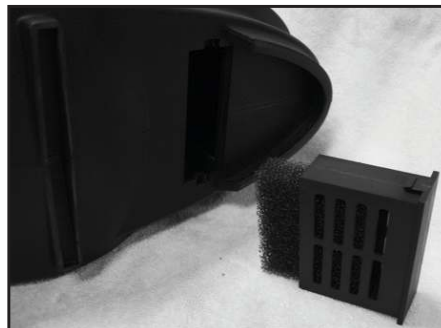

Air Filter



Air Filter

Air Hose

- Wipe the air hose daily with a damp cloth and store in a clean dry place.

Spray Gun

- It is important to clean your Spray Gun daily.
- At the end of the day or when the equipment will not be used any more, disconnect the Spray Gun from the air hose.
- Carefully unscrew the cup. If there is remaining solution, either close the cup with a cup lid, or pour the remaining solution into a proper storage container.

M1000 Spray Tan System (Cont'd)

- Rinse the cup under warm running water until clean.
- Fill the cup about ¼ full with water. Reconnect Spray Gun to Air Hose. Turn on the M1000 HVLP Unit. Direct the Spray Gun to a safe area and spray the clean warm water through the Spray Gun until the cup is empty.
- Turn off the M1000 HVLP Unit. Disconnect the Spray Gun. Unscrew the cup.
- Wipe all exposed areas dry.
- Unscrew and remove the Air Cap Ring (#1). Rinse the threads under warm running water. Wipe, clean the threads and dry. Add a small amount of Spray Gun lube to the threads.
- Remove the Air Cap (#2). Rinse under warm running water. Wipe, clean and dry.
- If necessary, remove Air Distributor Plate (#5). Rinse under warm running water. Wipe clean, dry and lubricate with Spray Gun lube.
- Reinstall the three pieces you just removed by reversing the removal procedure. Your Spray Gun should be ready for the next use. Store the Spray Gun in the holder on the M1000 HVLP Unit.
- The Solution nozzle (#3) can be removed for additional cleaning if necessary. Be careful. There is a Solution nozzle gasket (#4) around the threads of the Solution nozzle. Be sure to reinstall or leakage will occur. Removal of the Solution nozzle is not necessary on a daily basis. You should however remove it once a week and rinse under running water. The Solution nozzle can be easily removed with an adjustable wrench or spanner. Place the tip of your adjustable wrench or spanner on the two flat areas of the nozzle and twist anti or counter clockwise.
- The Solution needle (#10) can also be removed for additional maintenance. To remove: Turn the Solution Flow Screw anti or counter clockwise until it comes out of the Spray Gun. Be careful when removing the Solution Flow Screw as there is a small spring (#9) around the needle. Do not lose it. This is important to the operation of the Spray Gun. Set the spring aside and pull the trigger all the way back until you can grab the needle with your finger tips and pull it out from the back of the Spray Gun. Once removed, rinse under warm running water, clean and dry. Reinstall reversing the removal procedure. NOTE: Occasionally it is necessary to lubricate the needle (#10) where it slides through the gland nut (#7). Simply rub a few drops of Spray Gun lube around the needle shaft and reinsert into the back of the Spray Gun.

Troubleshooting

1. M1000 HVLP unit turned ON. Air blows out of M1000 Spray Gun?
 - This is correct. Air blows constantly when HVLP unit is ON.
2. M1000 HVLP unit turned ON. Unit does not operate or blow air?
 - Check that the unit is plugged in to proper electric source. Be sure there is power at the electric source. If there is no problem with electric supply, call for technical support.
3. M1000 HVLP unit is turned ON, the trigger is pulled back on Spray Gun, but no solution comes out?
 - Check that the cup is screwed firmly to Spray Gun.

Troubleshooting (Cont'd)

- Check that there is no solution bubbling or leaking around the cup.
 - Turn M1000 HVLP unit OFF. Unscrew cup. Be sure that Solution Tube and Disc (#14) is connected and has not come loose. Locate the two small holes in the Disc around the Solution tube. Be sure that these two small holes are not clogged with dried solution. To clean, carefully insert a pin through each hole ensuring that they are clear.
 - Turn M1000 HVLP Turbo unit OFF. Remove air cap ring, Remove air cap, Remove Air Distributor Plate. Remove Solution nozzle (#3) with an adjustable wrench or spanner. There is a Solution nozzle gasket (#4) on the Solution nozzle. Do not lose it. Rinse Solution Nozzle under running water and check for dried solution that may have blocked the hole. Reinstall Solution Nozzle Gasket. Reinstall Solution Nozzle, Air distributor plate, air cap and air cap ring. Try spraying again. If you still have a problem, call for technical support.
4. Solution leaks in front of trigger.
- With an adjustable wrench or spanner tighten Solution Needle Packing Screw (#7). Do not over tighten. This can cause Solution needle to stick and not spring back. Try spraying again. If leaking continues the Solution Needle Packing needs to be replaced. (Rare). Remove Solution Needle Packing Screw (#7). Pry out the Solution Needle Packings (4). Replace. Reinstall Solution Needle Packing Screw. Tighten all the way, and then back off slightly. (1/8 turn) Test spray gun for leakage. If you still have a problem call technical support.
5. When M1000 HVLP unit is ON, Solution continues to spray from Spray Gun without trigger being pulled.
- Immediately turn M1000 HVLP unit OFF.
 - Disconnect spray gun from air hose.
 - Slightly adjust (loosen) Solution Needle Packing Screw (#7). Test to see if problem is resolved.
 - Check to see that Needle Spring is installed. (#9). Remove Solution Flow Screw (#10). Look for Needle Spring around the back of the Solution Needle. (See diagram). If lost, call for replacement.
 - Check Solution nozzle. Remove and clean following directions 9.c.iv. Above.
6. Solution leaks around the top of the cup.
- Make sure the cup is screwed firmly to the body of the Spray Gun.
 - Make sure the threads around the cup are clean and the threads inside the cup top assembly are clean.
 - Replace the cup top gasket. Pry out old gasket. Install new gasket. Test spray gun.

Warranty and Technical Support

For all technical questions please call Norvell, A Division of Sunless, Inc. at 888-829-2831. For spraying technique visit norvelltanning.com.

Technical Support: Available Monday–Friday, 8am–4:30pm, CST.
Norvell, A Division of Sunless, Inc.
888-829-2831
norvelltanning.com

One year Limited Warranty

This machine and Equipment is WARRANTED by Norvell, A Division of Sunless, Inc. for a total period of one year from the ORIGINAL date of purchase by the ORIGINAL PURCHASER. Proof of purchase should be included and all SHIPPING CHARGES to be pre-paid.

NORVELL SPRAY SYSTEMS, upon examination of the machine/equipment will replace or repair at their discretion any defects in material or workmanship.

This WARRANTY does NOT include: miss-use, damage, neglect, alterations, disassembled equipment or modifications, lack of maintenance, cleaning, water damage to electrical parts and INCORRECT VOLTAGE CONNECTION. This WARRANTY is in lieu of all other express warranties, any WARRANTY implied by law, including but not limited to implied warranties of merchantability or fitness, is excluded to the maximum extent permitted by law and, if not excludable, it is limited to the duration of the express Warranty. No representative or person is authorized to extend this Warranty or to create for NORVELL SPRAY SYSTEMS, any other liability in connection with the sale of any NORVELL SPRAY SYSTEMS product. NORVELL SPRAY SYSTEMS shall not be liable for any consequential, incidental, or special damages of any kind directly or indirectly resulting from breach of any express or implied Warranty. Some States do allow the exclusion of limitation of incidental or consequential damages or limitations on the length of any Warranty so that the above limitations and exclusions may not apply to you; however, to the maximum extent permitted under applicable law, the only rights and remedies shall be to obtain a replacement for any defective product. This Warranty gives you specific legal rights and you may also have other rights which vary from state to state and country to country.

Norvell, A Division of Sunless, Inc.
Customer Service 888-829-2831 or 615-529-1250
norvelltanning.com

**DO NOT USE EQUIPMENT BEFORE
READING THIS MANUAL!**

This manual contains important warnings and instructions.
Please read these instructions carefully and keep for your reference.

NORVELL®

8909 S. Freeway Dr. | Macedina, OH 48056 | 888.829.2831 | 615.529.1250 | norvelltanning.com
Norvell® is a registered trademark of Sunless, Inc. © 1983–2020 Norvell, A Division of Sunless, Inc. All Rights Reserved.